



STAINLESS DISMOUNTABLE BELLOW



From nominal diameter 4''^{1/2} (Ø110mm)
to nominal diameter 16'' (Ø400mm)

High resistant corrosion with components in stainless steel
Wide range (1,2,3 convolutes)
High temperature on demand

Bellow 4"½ x 1 Stainless steel

DB0414

INDUSTRY

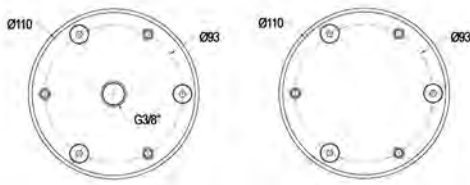
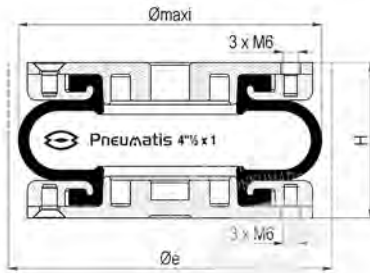

Technical characteristics

Maximum pressure	8 bar
Burst pressure	24 bar
Maximum angular capacity	10°
Maximum out of alignment	10 mm

Static diameter	114 mm
Maximum diameter	125 mm
Minimum overall diameter (Øe)	140 mm
Minimum height	45 mm
Static height (H)	65 mm
Maximum height	90 mm
Maximum recommended height	80 mm
Total stroke	45 mm
Effective area at static height	72 cm ²
Stiffness at 4 bar	55 daN/mm
Natural frequency at 4 bar	5,74 Hz
Weight	0,8 kg

Dynamic characteristics at H = 72mm*

Pressure	2 bar	4 bar	6 bar
Load (daN)	105	220	335
Volume (dm ³)	0,316	0,340	0,365
Stiffness (daN/mm)	74,9	131,8	184,9
Natural frequency (Hz)	4,21	3,87	3,71
Isolation rate at 10Hz %	78,4%	82,4%	84,0%

* Recommended height for better isolation

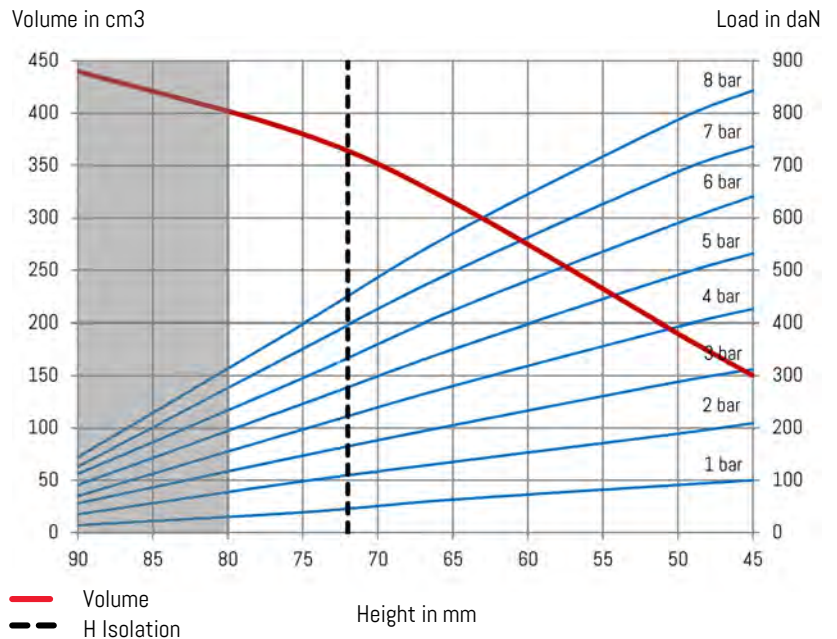

Temperatures

Standard	-40°C (-50°C static)	+70°C (+90°C static)
----------	----------------------	----------------------

References

DB0414	Bellow 1 convolute 4" 1/2 x 1 Stainless steel screwed air inlet G3/8" centered
--------	--

Characteristics in static condition (daN)

Height	2 bar	3 bar	4 bar	5 bar	6 bar	7 bar	8 bar	Vol 5 bar
45	209	312	426	532	641	737	843	150
50	189	288	393	491	590	688	787	190
65	135	205	280	350	423	497	570	315
72	109	165	223	279	336	398	455	360
75	98	147	197	246	295	351	398	380
80	77	117	157	197	238	281	321	402
90	35	56	70	91	112	126	144	440

Mounting instructions

Fastening torque M6 x 1 : 7 to 11 Nm

Indicative value of force to reach the minimum height at atmospheric pressure is 12 daN.

Bellow 4" ½ x 2 Stainless steel

DB0423

INDUSTRY

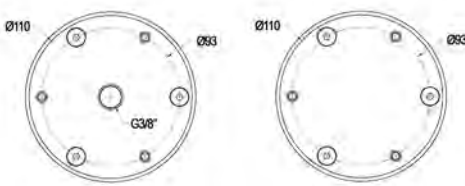
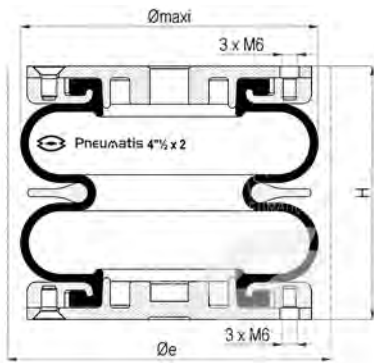

Technical characteristics

Maximum pressure	8 bar
Burst pressure	24 bar
Maximum angular capacity	10°
Maximum out of alignment	10 mm

Static diameter	114 mm
Maximum diameter	125 mm
Minimum overall diameter (Øe)	140 mm
Minimum height	65 mm
Static height (H)	100 mm
Maximum height	145 mm
Maximum recommended height	135 mm
Total stroke	80 mm
Effective area at static height	58 cm ²
Stiffness at 4 bar	12,50 daN/mm
Natural frequency at 4 bar	3 Hz
Weight	1 kg

Dynamic characteristics at H = 130mm*

Pressure	2 bar	4 bar	6 bar
Load (daN)	75	170	260
Volume (dm ³)	0,628	0,655	0,683
Stiffness (daN/mm)	26,5	49,5	71,4
Natural frequency (Hz)	2,94	2,71	2,62
Isolation rate at 10Hz %	90,6%	92,1%	92,6%

* Recommended height for better isolation

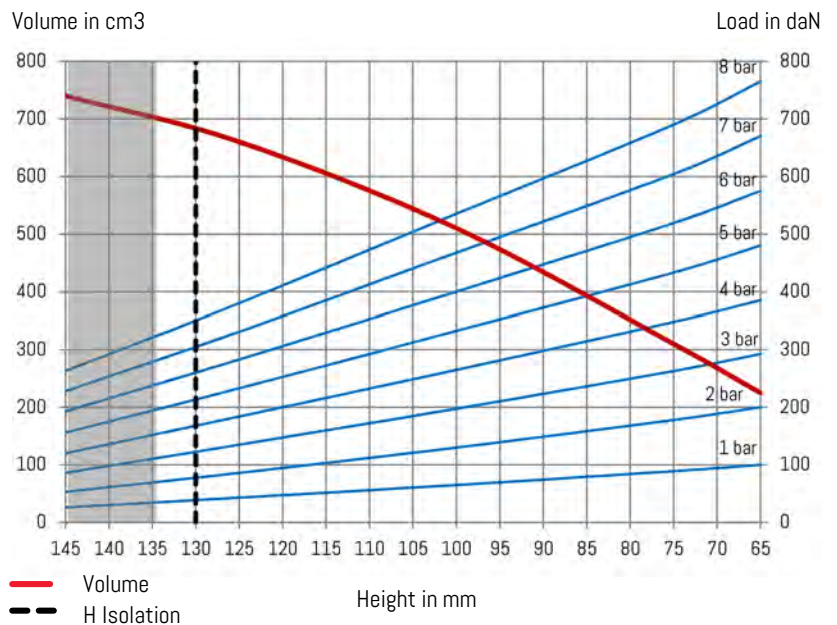

Temperatures

Standard	-40°C (-50°C static)	+70°C (+90°C static)
----------	----------------------	----------------------

References

DB0423	Bellow 2 convolutes 4" ½ x 2 Stainless steel screwed air inlet G ^{3/8} centered
--------	--

Characteristics in static condition (daN)

Height	2 bar	3 bar	4 bar	5 bar	6 bar	7 bar	8 bar	Vol 5 bar
65	200	293	385	480	575	670	765	225
75	178	263	348	433	519	604	690	310
100	130	198	265	333	400	468	535	510
125	86	135	184	233	283	331	380	660
130	77	123	167	213	260	306	351	681
135	69	111	151	193	238	280	321	703
145	53	86	120	156	193	228	263	740

Mounting instructions

Fastening torque M6 x 1 : 7 to 11 Nm

Indicative value of force to reach the minimum height at atmospheric pressure is 13 daN.

Bellow 4" ½ x 3 Stainless steel

DB0436

INDUSTRY

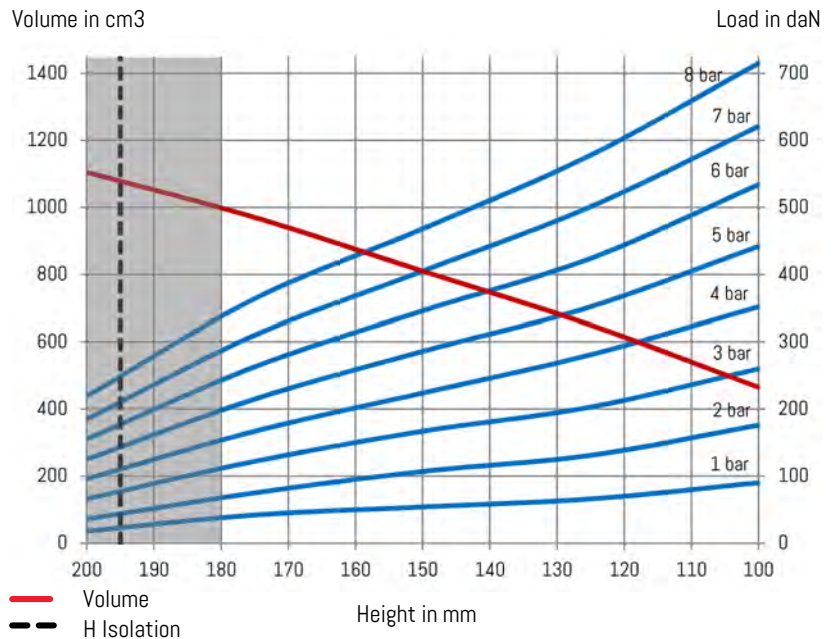
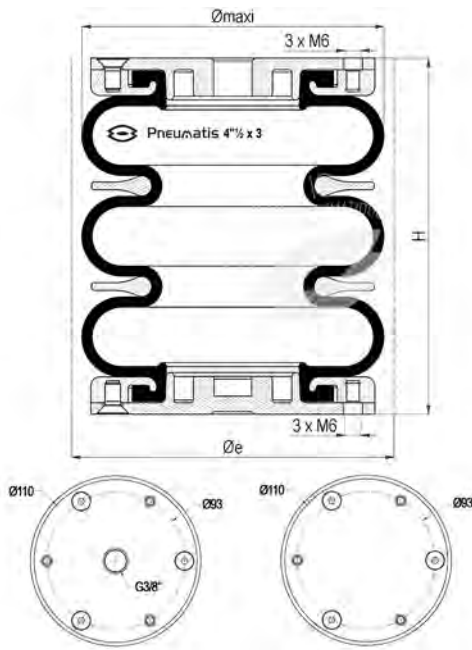

Technical characteristics

Maximum pressure	8 bar
Burst pressure	24 bar
Maximum angular capacity	10°
Maximum out of alignment	10 mm

Static diameter	114 mm
Maximum diameter	125 mm
Minimum overall diameter (Øe)	140 mm
Minimum height	100 mm
Static height (H)	145 mm
Maximum height	200 mm
Maximum recommended height	180 mm
Total stroke	100 mm
Effective area at static height	60 cm²
Stiffness at 4 bar	8 daN/mm
Natural frequency at 4 bar	2,5 Hz
Weight	1,2 kg

Dynamic characteristics at H = 195mm*

Pressure	2 bar	4 bar	6 bar
Load (daN)	65	150	240
Volume (dm³)	0,94	1,01	1,08
Stiffness (daN/mm)	13,1	25,5	36,8
Natural frequency (Hz)	2,20	2,04	1,96
Isolation rate at 10Hz %	94,9%	95,7%	96,0%

* Recommended height for better isolation

Temperatures

Standard	-40°C (-50°C static)	+70°C (+90°C static)
----------	----------------------	----------------------

References

DB0436	Bellow 3 convolutes 4" ½ x 3 Stainless steel screwed air inlet G3/8 centered
--------	--

Characteristics in static condition (daN)

Height	2 bar	3 bar	4 bar	5 bar	6 bar	7 bar	8 bar	Vol 5 bar
100	176	260	352	442	534	621	715	465
125	131	203	281	352	424	501	578	650
145	112	174	237	300	363	427	495	783
150	107	167	224	286	346	405	468	810
175	75	122	167	215	263	310	364	970
180	66	108	149	191	235	278	326	997
195	47	79	111	144	179	213	252	1080
200	36	66	96	125	155	185	219	1105

Mounting instructions

Fastening torque M6 x 1 : 7 to 11 Nm

Indicative value of force to reach the minimum height at atmospheric pressure is 14 daN.



Bellow 6" x 1 Stainless steel

DB06113

INDUSTRY

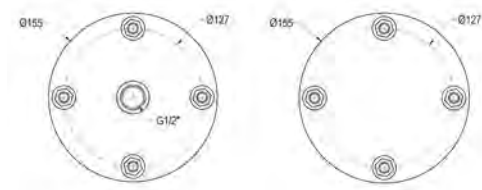
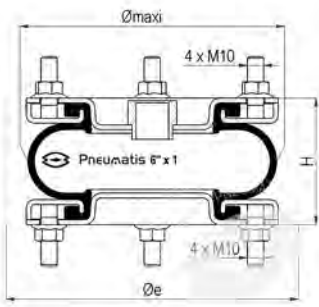

Technical characteristics

Maximum pressure	8 bar
Burst pressure	24 bar
Maximum angular capacity	10°
Maximum out of alignment	10 mm

Static diameter	152 mm
Maximum diameter	175 mm
Minimum overall diameter (Øe)	190 mm
Minimum height	50 mm
Static height (H)	80 mm
Maximum height	105 mm
Maximum recommended height	95 mm
Total stroke	55 mm
Effective area at static height	106 cm ²
Stiffness at 4 bar	76,70 daN/mm
Natural frequency at 4 bar	3,20 Hz
Weight	2,5 kg

Dynamic characteristics at H = 85mm*

Pressure	2 bar	4 bar	6 bar
Load (daN)	170	365	570
Volume (dm ³)	0,76	0,78	0,81
Stiffness (daN/mm)	94,3	174,0	249,0
Natural frequency (Hz)	3,71	3,43	3,30
Isolation rate at 10Hz %	84,1%	86,6%	87,8%

* Recommended height for better isolation

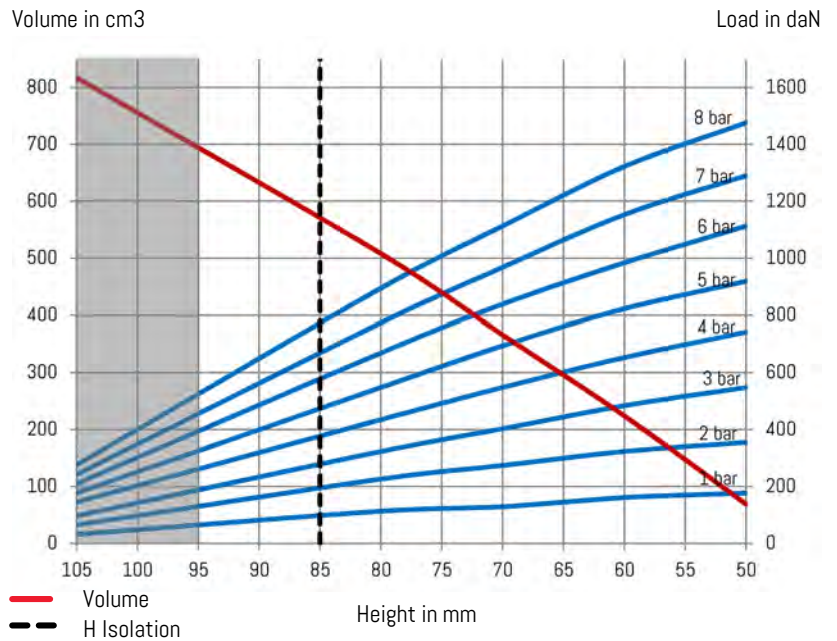

Temperatures

Standard	-40°C (-50°C static)	+70°C (+90°C static)
----------	----------------------	----------------------

References

DB06113	Bellow 1 convolute 6" x 1 stainless steel screwed air inlet G ^{1/2} centered
---------	---

Characteristics in static condition (daN)

Height	2 bar	3 bar	4 bar	5 bar	6 bar	7 bar	8 bar	Vol 5 bar
50	355	548	742	919	1 113	1 290	1 476	69
60	323	484	653	823	984	1 153	1 322	224
70	274	403	548	694	839	968	1 113	366
80	226	323	435	548	669	774	895	508
85	197	281	383	486	588	680	786	573
95	134	191	267	336	406	468	540	699
105	65	97	145	177	210	242	276	817

Mounting instructions

Fastening torque M10 x 1,5 : 20 to 28 Nm

Indicative value of force to reach the minimum height at atmospheric pressure is 14 daN.

Bellow 6" x 2 Stainless steel

DB06216

INDUSTRY

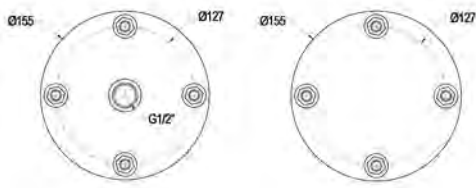
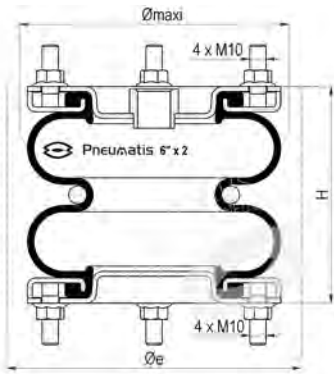

Technical characteristics

Maximum pressure	8 bar
Burst pressure	24 bar
Maximum angular capacity	10°
Maximum out of alignment	10 mm

Static diameter	152 mm
Maximum diameter	175 mm
Minimum overall diameter (Øe)	190 mm
Minimum height	70 mm
Static height (H)	130 mm
Maximum height	190 mm
Maximum recommended height	170 mm
Total stroke	120 mm
Effective area at static height	125 cm ²
Stiffness at 4 bar	24,9 daN/mm
Natural frequency at 4 bar	2,80 Hz
Weight	2,7 kg

Dynamic characteristics at H = 150mm*

Pressure	2 bar	4 bar	6 bar
Load (daN)	180	375	575
Volume (dm ³)	1,53	1,59	1,64
Stiffness (daN/mm)	45,5	81,7	116,9
Natural frequency (Hz)	2,51	2,33	2,25
Isolation rate at 10Hz %	93,3%	94,3%	94,7%

* Recommended height for better isolation

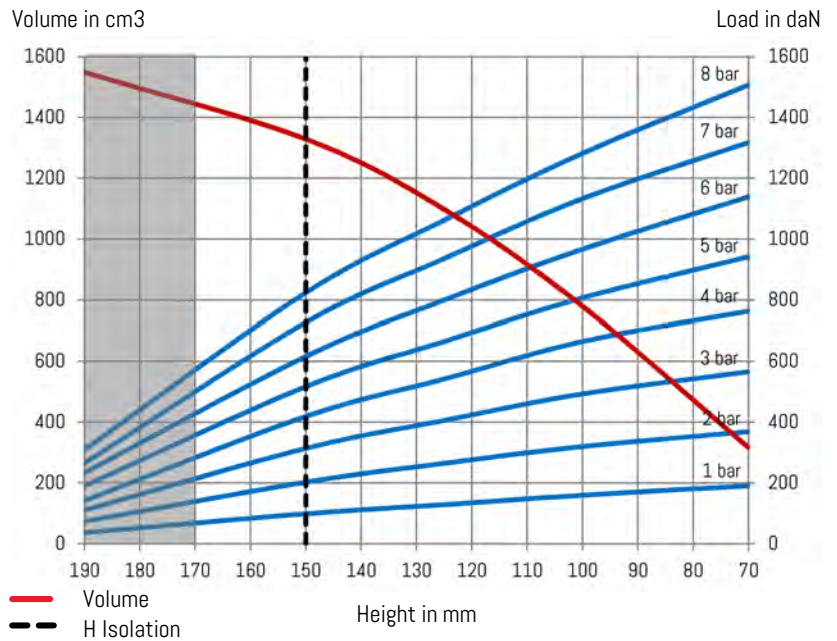

Temperatures

Standard	-40°C (-50°C static)	+70°C (+90°C static)
----------	----------------------	----------------------

References

DB06216	Bellow 2 convolutes 6" x 2 Stainless steel bolted air inlet G ^{1/2} centered
---------	---

Characteristics in static condition (daN)

Height	2 bar	3 bar	4 bar	5 bar	6 bar	7 bar	8 bar	Vol 5 bar
70	369	566	764	942	1 139	1 318	1 507	317
100	320	493	665	807	967	1 133	1 282	780
125	265	406	542	665	800	936	1 062	1098
130	254	391	525	641	768	902	1 021	1147
150	203	314	419	517	616	727	824	1329
170	142	216	287	359	433	505	575	1462
190	74	111	142	191	234	265	310	1549

Mounting instructions

Fastening torque M10 x 1,5 : 20 to 28 Nm

Indicative value of force to reach the minimum height at atmospheric pressure is 17 daN.

Bellow 6" x 3 Stainless steel

DB06310

INDUSTRY

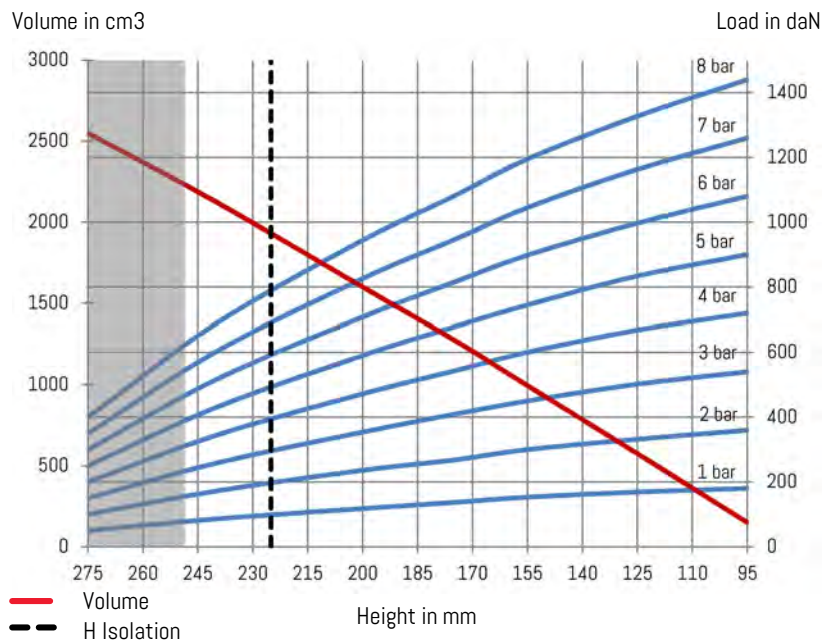
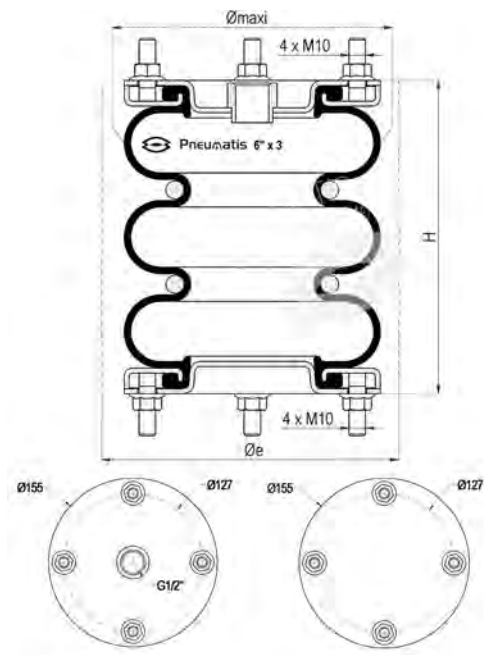

Technical characteristics

Maximum pressure	8 bar
Burst pressure	24 bar
Maximum angular capacity	10°
Maximum out of alignment	10 mm

Static diameter	152 mm
Maximum diameter	175 mm
Minimum overall diameter (Øe)	190 mm
Minimum height	95 mm
Static height (H)	190 mm
Maximum height	275 mm
Maximum recommended height	250 mm
Total stroke	180 mm
Effective area at static height	117 cm ²
Stiffness at 4 bar	11,70 daN/mm
Natural frequency at 4 bar	2,04 Hz
Weight	3,0 kg

Dynamic characteristics at H = 225mm*

Pressure	2 bar	4 bar	6 bar
Load (daN)	170	360	545
Volume (dm ³)	2,17	2,30	2,42
Stiffness (daN/mm)	29,1	52,7	75,5
Natural frequency (Hz)	2,07	1,91	1,85
Isolation rate at 10Hz %	95,5%	96,2%	96,5%

* Recommended height for better isolation

Temperatures

Standard	-40°C (-50°C static)	+70°C (+90°C static)
----------	----------------------	----------------------

References

DB06310	Bellow 3 convolutes 6" x 3 bolted Stainless steel bolted air inlet G1/2 centered
---------	--

Characteristics in static condition (daN)

Height	2 bar	3 bar	4 bar	5 bar	6 bar	7 bar	8 bar	Vol 5 bar
95	360	540	720	900	1 080	1 260	1 440	150
125	332	502	668	834	997	1 163	1 327	575
155	300	450	600	745	898	1 045	1 195	995
175	268	409	543	678	815	946	1 081	1275
190	250	378	503	629	754	879	1 006	1470
200	236	354	472	590	708	826	944	1600
225	194	293	390	490	586	685	784	1926
240	172	258	344	430	516	602	688	2125
250	149	225	299	378	450	528	606	2242
275	100	150	200	250	300	350	400	2550

Mounting instructions

Fastening torque M10 x 1,5 : 20 to 28 Nm

Indicative value of force to reach the minimum height at atmospheric pressure is 19 daN.



Bellow 8" x 1 Stainless steel

DB0819

INDUSTRY

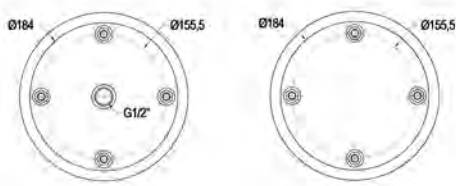
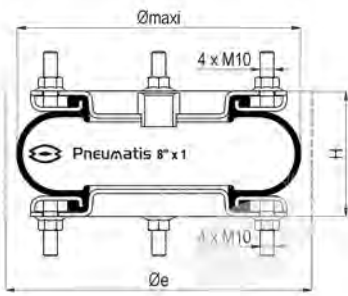

Technical characteristics

Maximum pressure	8 bar
Burst pressure	24 bar
Maximum angular capacity	10°
Maximum out of alignment	10 mm

Static diameter	203 mm
Maximum diameter	230 mm
Minimum overall diameter (Øe)	245 mm
Minimum height	50 mm
Static height (H)	90 mm
Maximum height	125 mm
Maximum recommended height	115 mm
Total stroke	75 mm
Effective area at static height	208 cm ²
Stiffness at 4 bar	56,00 daN/mm
Natural frequency at 4 bar	3,00 Hz
Weight	3,05 kg

Dynamic characteristics at H = 100mm*

Pressure	2 bar	4 bar	6 bar
Load (daN)	355	725	1105
Volume (dm ³)	1,83	1,90	1,96
Stiffness (daN/mm)	134,0	237,9	342,1
Natural frequency (Hz)	3,05	2,86	2,77
Isolation rate at 10Hz %	89,7%	91,1%	91,7%

* Recommended height for better isolation

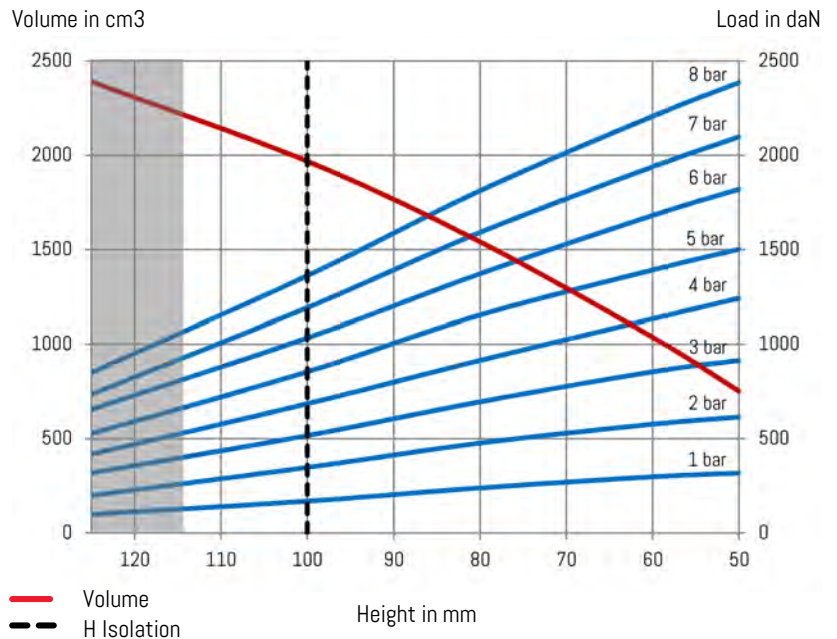

Temperatures

Standard	-40°C (-50°C static)	+70°C (+90°C static)
----------	----------------------	----------------------

References

DB0819	Bellow 1 convolute 8" x 1 Stainless steel bolted air inlet G1/2 centered
--------	--

Characteristics in static condition (daN)

Height	2 bar	3 bar	4 bar	5 bar	6 bar	7 bar	8 bar	Vol 5 bar
50	615	915	1 243	1 502	1 820	2 098	2 386	752
60	577	855	1 134	1 392	1 681	1 939	2 207	1037
80	477	696	915	1 154	1 372	1 591	1 812	1541
90	415	610	801	1 008	1 206	1 396	1 591	1764
100	348	517	686	855	1 034	1 193	1 362	1968
115	263	400	526	665	811	925	1 062	2236
125	199	318	418	527	656	736	851	2390

Mounting instructions

Fastening torque M10 x 1,5 : 20 to 28 Nm

Indicative value of force to reach the minimum height at atmospheric pressure is 12 daN.

Bellow 8" x 2 Stainless steel

DB08214

INDUSTRY

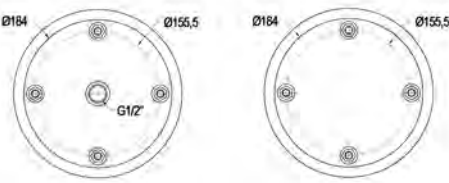
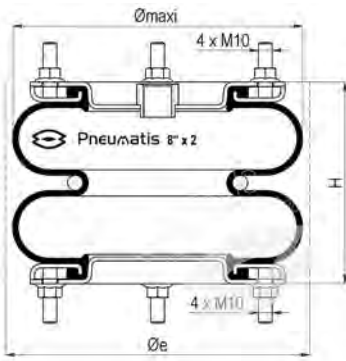

Technical characteristics

Maximum pressure	8 bar
Burst pressure	24 bar
Maximum angular capacity	10°
Maximum out of alignment	10 mm

Static diameter	203 mm
Maximum diameter	230 mm
Minimum overall diameter (Øe)	245 mm
Minimum height	70 mm
Static height (H)	160 mm
Maximum height	250 mm
Maximum recommended height	220 mm
Total stroke	180 mm
Effective area at static height	220 cm ²
Stiffness at 4 bar	20,00 daN/mm
Natural frequency at 4 bar	2,20 Hz
Weight	3,75kg

Dynamic characteristics at H = 200mm*

Pressure	2 bar	4 bar	6 bar
Load (daN)	265	545	840
Volume (dm ³)	3,42	3,54	3,66
Stiffness (daN/mm)	48,8	88,2	128,1
Natural frequency (Hz)	2,15	2,00	1,95
Isolation rate at 10Hz %	95,2%	95,8%	96,1%

* Recommended height for better isolation

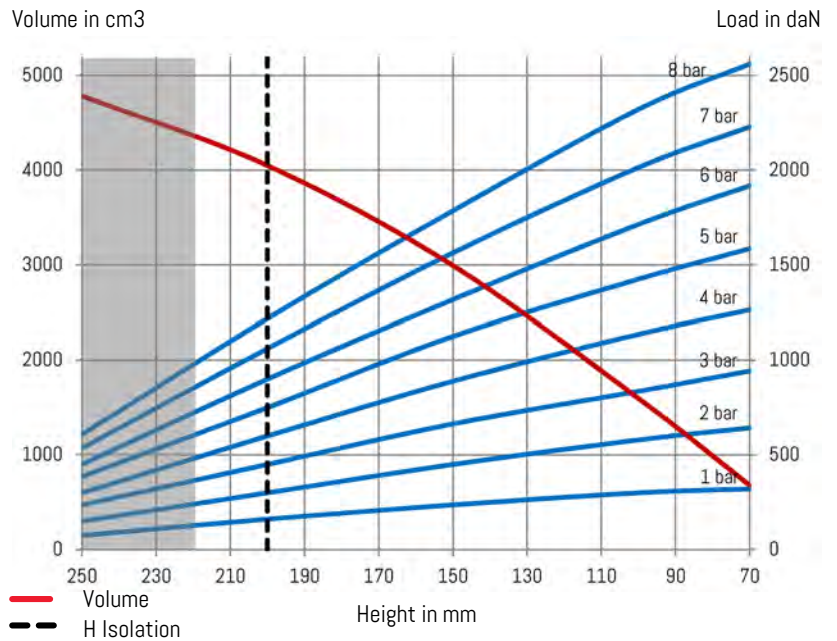

Temperatures

Standard	-40°C (-50°C static)	+70°C (+90°C static)
----------	----------------------	----------------------

References

DB08214	Bellow 2 convolutes 8" x 2 Stainless steel bolted air inlet G ^{1/2} centered
---------	---

Characteristics in static condition (daN)

Height	2 bar	3 bar	4 bar	5 bar	6 bar	7 bar	8 bar	Vol 5 bar
70	643	943	1 264	1 586	1 918	2 229	2 561	680
100	579	836	1 136	1 425	1 714	2 014	2 321	1598
150	450	664	889	1 125	1 318	1 564	1 786	2995
160	421	619	831	1 048	1 240	1 468	1 683	3221
200	300	450	600	750	900	1 061	1 218	4050
220	245	371	485	618	724	861	984	4375
250	150	236	300	386	450	536	608	4785

Mounting instructions

Fastening torque M10 x 1,5 : 20 to 28 Nm

Indicative value of force to reach the minimum height at atmospheric pressure is 13 daN.



Bellow 8" x 3 Stainless steel

DB08311

INDUSTRY

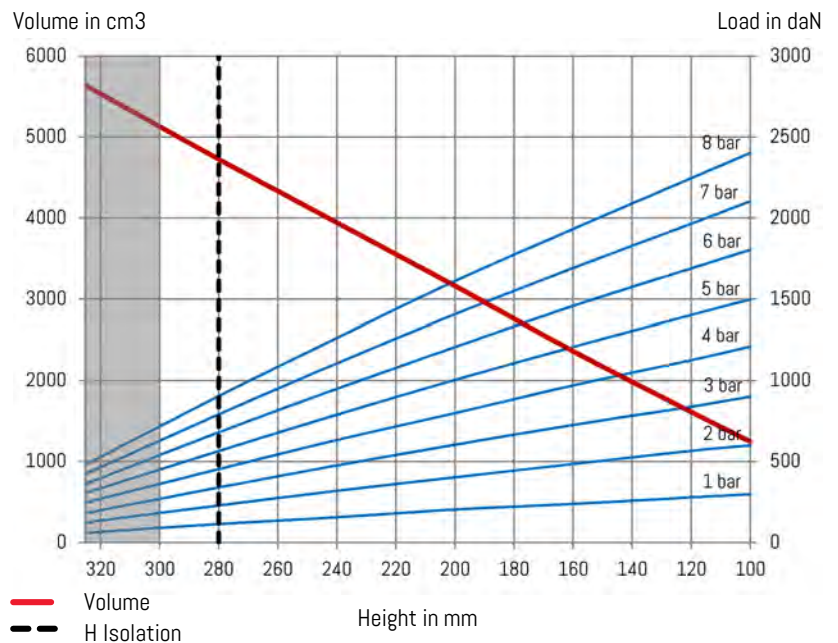
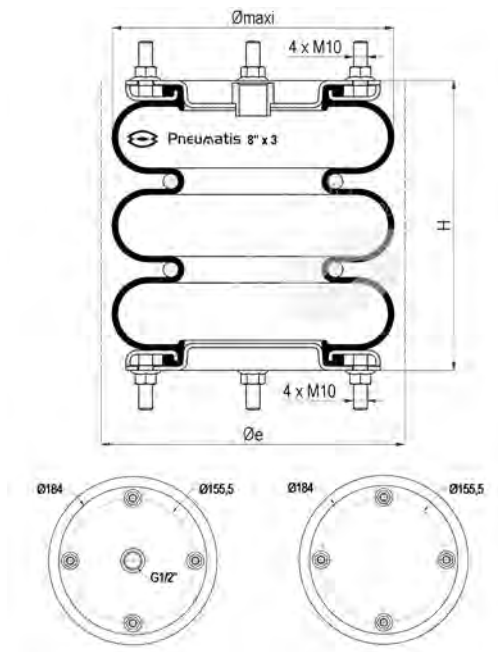

Technical characteristics

Maximum pressure	8 bar
Burst pressure	24 bar
Maximum angular capacity	10°
Maximum out of alignment	10 mm

Static diameter	204 mm
Maximum diameter	230 mm
Minimum overall diameter (Øe)	245 mm
Minimum height	100 mm
Static height (H)	205 mm
Maximum height	325 mm
Maximum recommended height	300 mm
Total stroke	225 mm
Effective area at static height	194 cm ²
Stiffness at 4 bar	11,75 daN/mm
Natural frequency at 4 bar	1,75 Hz
Weight	4,3 kg

Dynamic characteristics at H = 280mm*

Pressure	2 bar	4 bar	6 bar
Load (daN)	250	535	820
Volume (dm ³)	4,77	5,05	5,32
Stiffness (daN/mm)	33,4	60,2	85,1
Natural frequency (Hz)	1,82	1,67	1,60
Isolation rate at 10Hz %	96,6%	97,1%	97,4%

* Recommended height for better isolation

Temperatures

Standard	-40°C (-50°C static)	+70°C (+90°C static)
----------	----------------------	----------------------

References

DB08311	Bellow 3 convolutes 8" x 3 Stainless steel bolted air inlet G ^{1/2} centered
---------	---

Characteristics in static condition (daN)

Height	2 bar	3 bar	4 bar	5 bar	6 bar	7 bar	8 bar	Vol 5 bar
100	600	901	1 209	1 498	1 804	2 104	2 402	1246
120	566	839	1 126	1 402	1 689	1 965	2 246	1612
160	485	726	970	1 207	1 458	1 691	1 932	2362
200	403	604	799	1 004	1 206	1 407	1 611	3161
205	392	587	781	976	1 176	1 366	1 564	3249
240	319	476	633	789	949	1 106	1 262	3943
280	229	340	453	565	680	791	904	4726
300	180	269	364	451	539	626	718	5132
325	124	182	247	306	362	424	481	5635

Mounting instructions

Fastening torque M10 x 1,5 : 20 to 28 Nm

Indicative value of force to reach the minimum height at atmospheric pressure is 15 daN.

Bellow 10" x 1 Stainless steel

DB1018

INDUSTRY

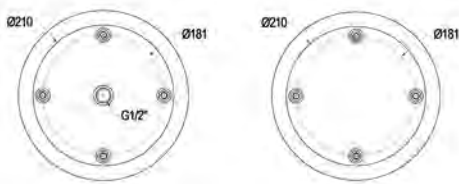
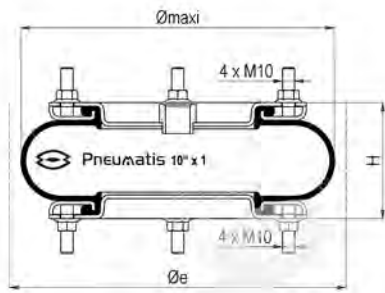

Technical characteristics

Maximum pressure	8 bar
Burst pressure	24 bar
Maximum angular capacity	15°
Maximum out of alignment	10 mm

Static diameter	254 mm
Maximum diameter	280 mm
Minimum overall diameter (Øe)	300 mm
Minimum height	50 mm
Static height (H)	100 mm
Maximum height	150 mm
Maximum recommended height	135 mm
Total stroke	100 mm
Effective area at static height	295 cm ²
Stiffness at 4 bar	60,00 daN/mm
Natural frequency at 4 bar	2,60 Hz
Weight	3,9 kg

Dynamic characteristics at H = 120mm*

Pressure	2 bar	4 bar	6 bar
Load (daN)	505	1045	1580
Volume (dm ³)	3,37	3,53	3,69
Stiffness (daN/mm)	150	271	385
Natural frequency (Hz)	2,71	2,54	2,46
Isolation rate at 10Hz %	92,1%	93,1%	93,5%

* Recommended height for better isolation

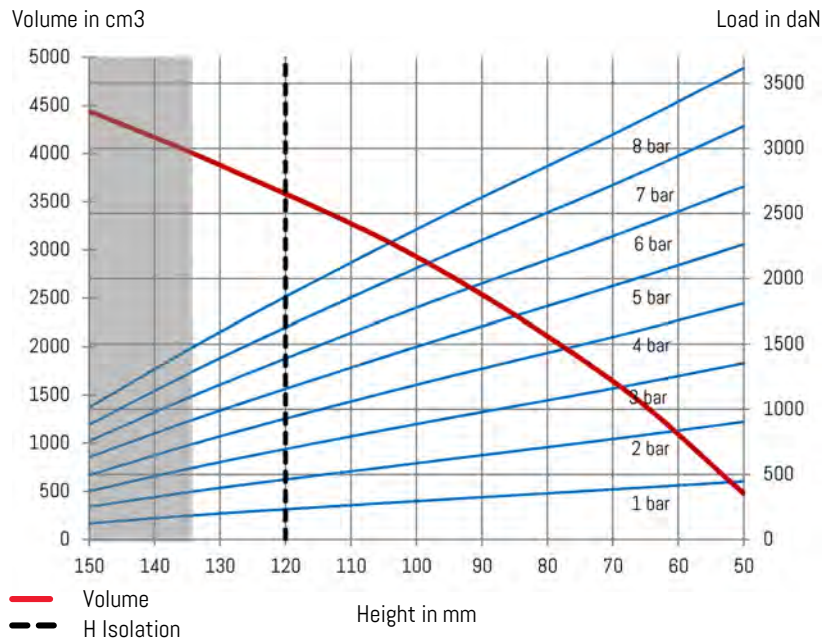

Temperatures

Standard	-40°C (-50°C static)	+70°C (+90°C static)
----------	----------------------	----------------------

References

DB1018	Bellow 1 convolute 10" x 1 Stainless steel bolted air inlet G ^{1/2} centered
--------	---

Characteristics in static condition (daN)

Height	2 bar	3 bar	4 bar	5 bar	6 bar	7 bar	8 bar	Vol 5 bar
50	904	1 354	1 811	2 263	2 707	3 170	3 618	479
70	772	1 160	1 554	1 944	2 326	2 719	3 106	1645
100	586	887	1 189	1 480	1 778	2 080	2 378	2930
120	456	689	921	1 150	1 382	1 616	1 848	3636
130	397	595	793	991	1 189	1 393	1 593	3880
135	356	536	714	897	1 077	1 259	1 442	4065
150	252	372	495	634	758	883	1 015	4442

Mounting instructions

Fastening torque M10 x 1,5 : 20 to 28 Nm

Indicative value of force to reach the minimum height at atmospheric pressure is 10 daN.



Bellow 10" x 2 Stainless steel

DB10229

INDUSTRY

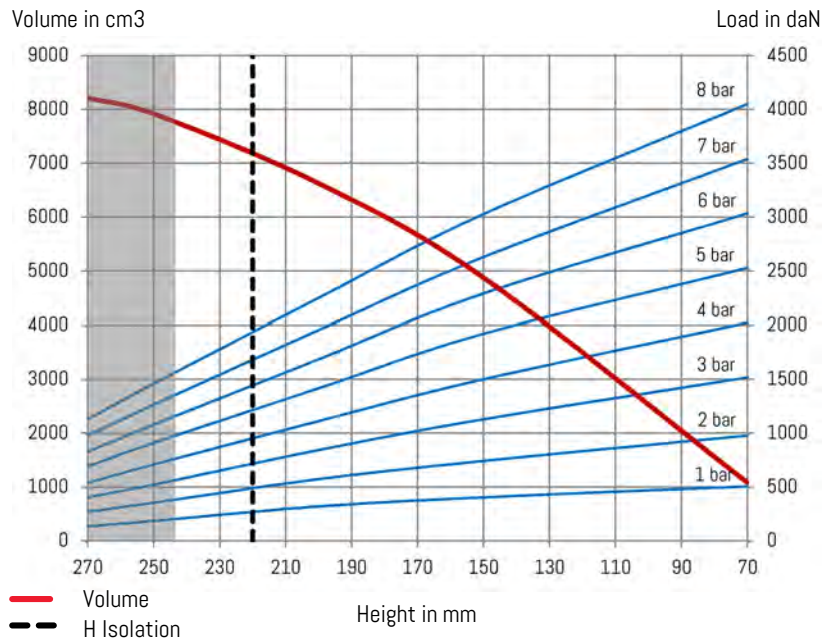
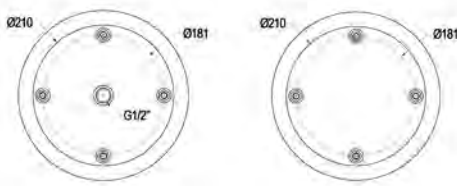
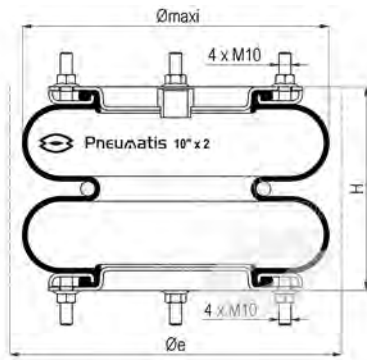

Technical characteristics

Maximum pressure	8 bar
Burst pressure	24 bar
Maximum angular capacity	15°
Maximum out of alignment	10 mm

Static diameter	254 mm
Maximum diameter	280 mm
Minimum overall diameter (Øe)	300 mm
Minimum height	70 mm
Static height (H)	170 mm
Maximum height	270 mm
Maximum recommended height	245 mm
Total stroke	200 mm
Effective area at static height	340 cm ²
Stiffness at 4 bar	28,00 daN/mm
Natural frequency at 4 bar	1,95 Hz
Weight	5,0 kg

Dynamic characteristics at H = 220mm*

Pressure	2 bar	4 bar	6 bar
Load (daN)	470	960	1455
Volume (dm ³)	6,22	6,44	6,67
Stiffness (daN/mm)	70,2	125,4	178,8
Natural frequency (Hz)	1,93	1,80	1,75
Isolation rate at 10Hz %	96,1%	96,6%	96,8%

* Recommended height for better isolation

Temperatures

Standard	-40°C (-50°C static)	+70°C (+90°C static)
----------	----------------------	----------------------

References

DB10229 Bellow 2 convolutes 10" x 2 Stainless steel bolted air inlet G^{1/2} centered

Characteristics in static condition (daN)

Height	2 bar	3 bar	4 bar	5 bar	6 bar	7 bar	8 bar	Vol 5 bar
70	978	1 517	2 022	2 528	3 034	3 539	4 050	1083
150	742	1 129	1 500	1 921	2 292	2 629	3 028	4875
170	678	1 017	1 346	1 721	2 051	2 362	2 721	5642
200	573	843	1 112	1 416	1 685	1 955	2 251	6625
220	487	723	957	1 231	1 464	1 692	1 954	7184
245	381	565	749	964	1 148	1 338	1 545	7771
250	354	522	708	910	1 079	1 264	1 459	7917
270	270	404	539	691	826	978	1 128	8208

Mounting instructions

Fastening torque M10 x 1,5 : 20 to 28 Nm

Indicative value of force to reach the minimum height at atmospheric pressure is 10 daN.

Bellow 10" x 3 Stainless steel

DB10325

INDUSTRY

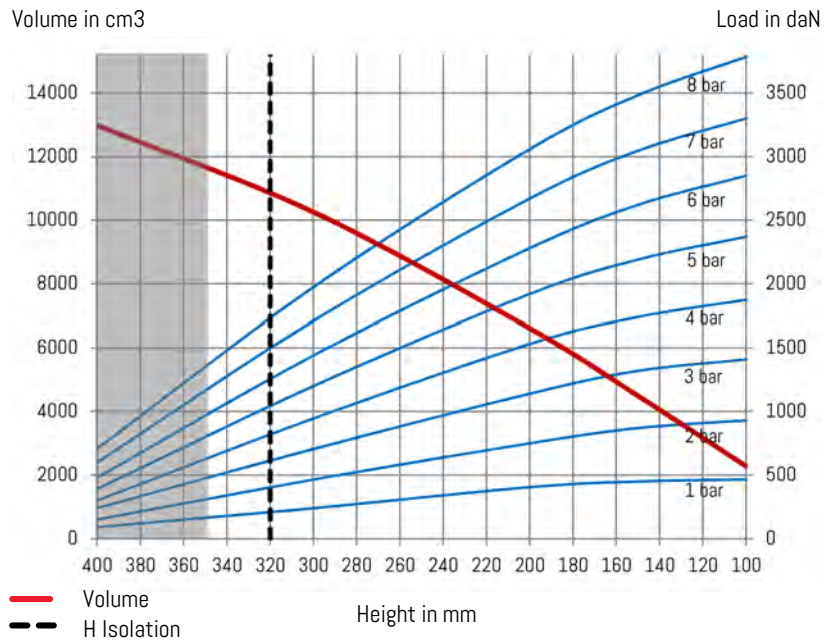
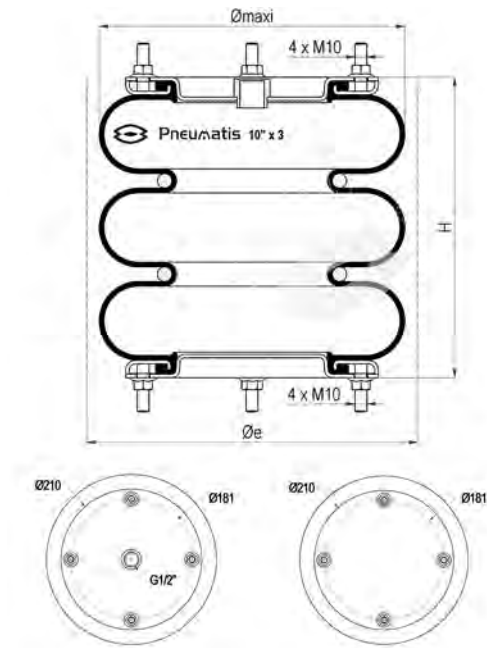

Technical characteristics

Maximum pressure	8 bar
Burst pressure	24 bar
Maximum angular capacity	15°
Maximum out of alignment	10 mm

Static diameter	254 mm
Maximum diameter	280 mm
Minimum overall diameter (Øe)	300 mm
Minimum height	100 mm
Static height (H)	250 mm
Maximum height	400 mm
Maximum recommended height	350 mm
Total stroke	300 mm
Effective area at static height	300 cm ²
Stiffness at 4 bar	20 daN/mm
Natural frequency at 4 bar	1,75 Hz
Weight	5,6 Kg

Dynamic characteristics at H = 320mm*

Pressure	2 bar	4 bar	6 bar
Load (daN)	435	875	1 340
Volume (dm ³)	9,32	9,65	9,98
Stiffness (daN/mm)	44	76	110
Natural frequency (Hz)	1,58	1,47	1,43
Isolation rate at 10Hz %	97,40%	97,80%	97,90%

* Recommended height for better isolation

Temperatures

Standard	-30°C (-40°C static)	+70°C (+90°C static)
----------	----------------------	----------------------

References

DB10325	Bellow 3 convolutes 10" x 3 2 ply Stainless steel bolted air inlet G ^{1/2} centered
---------	--

Characteristics in static condition (daN)

Height	2 bar	3 bar	4 bar	5 bar	6 bar	7 bar	8 bar	Vol 5 bar
100	930	1 410	1 875	2 370	2 850	3 300	3 784	2279
150	870	1 320	1 740	2 190	2 620	3 045	3 482	4494
200	750	1 140	1 530	1 920	2 280	2 670	3 058	6609
250	621	946	1 264	1 592	1 894	2 227	2 557	8516
300	465	705	945	1 200	1 440	1 710	1 974	10256
320	417	643	853	1 079	1 286	1 528	1 763	10828
350	319	499	654	832	995	1 192	1 382	11699
400	150	240	300	390	480	600	707	12981

Mounting instructions

Fastening torque M10 x 1,5 : 20 to 28 Nm

Indicative value of force to reach the minimum height at atmospheric pressure is 11 daN.



Bellow 10" x 3 reinforced Stainless steel

DB10328

INDUSTRY

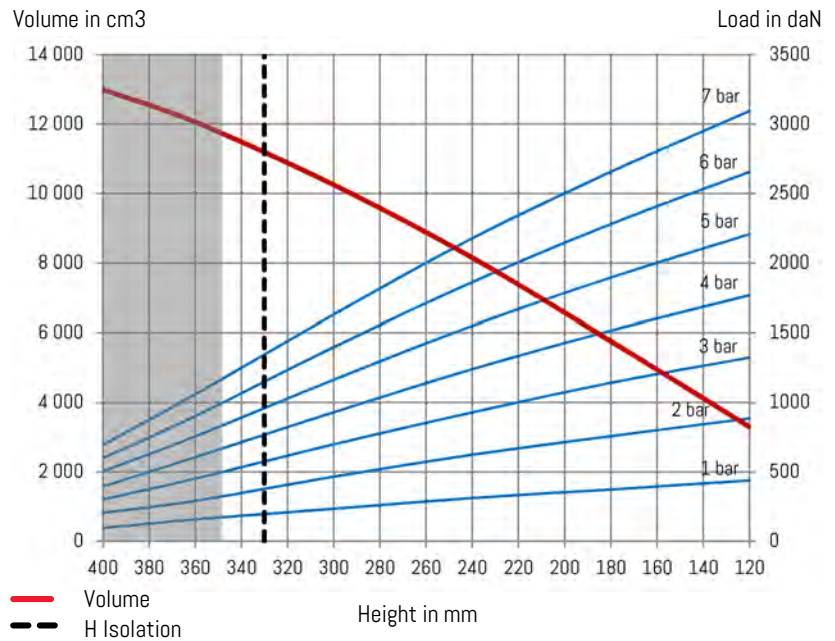
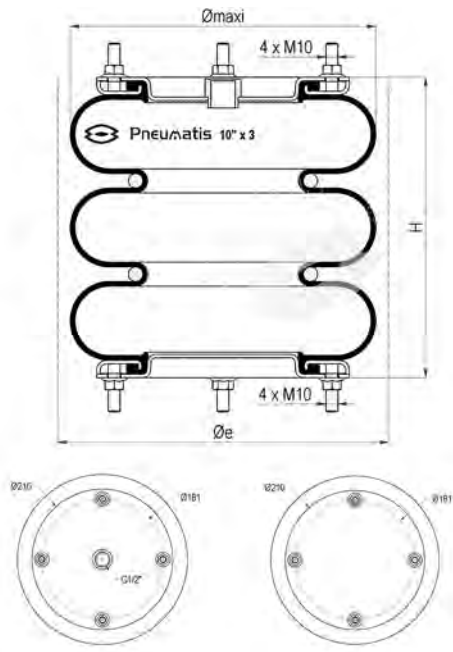

Technical characteristics

Maximum pressure	8 bar
Burst pressure	24 bar
Maximum angular capacity	15°
Maximum out of alignment	10 mm

Static diameter	254 mm
Maximum diameter	280 mm
Minimum overall diameter (Øe)	300 mm
Minimum height	120 mm
Static height (H)	250 mm
Maximum height	400 mm
Maximum recommended height	350 mm
Total stroke	280 mm
Effective area at static height	300 cm ²
Stiffness at 4 bar	20,00 daN/mm
Natural frequency at 4 bar	1,75 Hz
Weight	5,8 kg

Dynamic characteristics at H = 330mm*

Pressure	2 bar	4 bar	6 bar
Load (daN)	385	810	1235
Volume (dm ³)	9,1	9,2	9,2
Stiffness (daN/mm)	41	74	107
Natural frequency (Hz)	1,63	1,51	1,46
Isolation rate at 10Hz %	97,3%	97,7%	97,8%

* Recommended height for better isolation

Temperatures

Standard	-40°C (-50°C static)	+70°C (+90°C static)
----------	----------------------	----------------------

References

DB10328	Bellow 3 convolutes 10" x 3 4 ply reinforced Stainless steel bolted G1/2 centered
---------	---

Characteristics in static condition (daN)

Height	2 bar	3 bar	4 bar	5 bar	6 bar	7 bar	8 bar	Vol 5 bar
120	885	1 323	1 768	2 207	2 656	3 094		3 295
180	757	1 141	1 516	1 895	2 280	2 656		5 760
240	623	928	1 239	1 550	1 862	2 177	Contact us	8 150
250	592	890	1 183	1 478	1 782	2 077		8 523
300	465	698	929	1 163	1 397	1 630		10 251
330	388	585	772	968	1 170	1 358		11 147
350	335	505	664	834	1 008	1 168		11 730
360	291	451	605	755	901	1 058	12 060	
400	204	301	394	503	597	693	12 998	

Mounting instructions

Fastening torque M10 x 1,5 : 20 to 28 Nm

Indicative value of force to reach the minimum height at atmospheric pressure is 76 daN.

Bellow 12" x 1 Stainless steel

DB12112

INDUSTRY

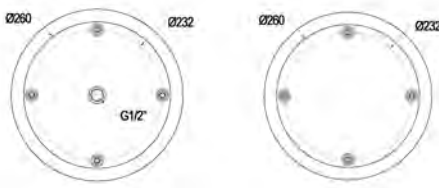
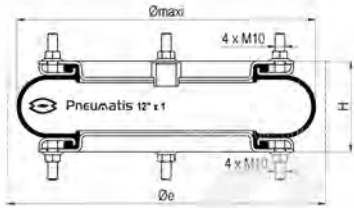

Technical characteristics

Maximum pressure	8 bar
Burst pressure	24 bar
Maximum angular capacity	15°
Maximum out of alignment	10 mm

Static diameter	305 mm
Maximum diameter	330 mm
Minimum overall diameter (Øe)	350 mm
Minimum height	50 mm
Static height (H)	100 mm
Maximum height	150 mm
Maximum recommended height	135 mm
Total stroke	100 mm
Effective area at static height	477 cm ²
Stiffness at 4 bar	87,00 daN/mm
Natural frequency at 4 bar	2,70 Hz
Weight	5,2 kg

Dynamic characteristics at H = 120mm*

Pressure	2 bar	4 bar	6 bar
Load (daN)	795	1625	2455
Volume (dm ³)	4,95	5,12	5,28
Stiffness (daN/mm)	230	413	588
Natural frequency (Hz)	2,69	2,51	2,44
Isolation rate at 10Hz %	92,2%	93,3%	93,7%

* Recommended height for better isolation

Volume in cm³

Load in daN

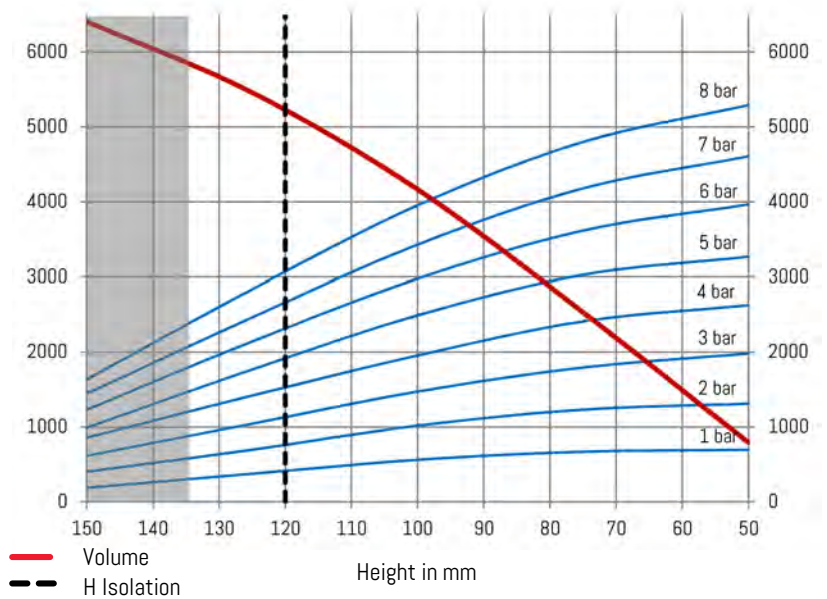

Temperatures

Standard	-40°C (-50°C static)	+70°C (+90°C static)
----------	----------------------	----------------------

References

DB12112	Bellow 1 convolute 12" x 1 Stainless steel bolted air inlet G ^{1/2} centered
---------	---

Characteristics in static condition (daN)

Height	2 bar	3 bar	4 bar	5 bar	6 bar	7 bar	8 bar	Vol 5 bar
50	1 312	1 982	2 625	3 268	3 964	4 607	5 291	792
75	1 232	1 795	2 411	3 027	3 616	4 179	4 799	2532
100	1 018	1 473	1 955	2 491	2 976	3 429	3 954	4165
120	795	1 161	1 567	1 966	2 360	2 718	3 127	5190
125	696	1 045	1 420	1 768	2 143	2 464	2 838	5459
135	603	897	1 222	1 499	1 820	2 104	2 411	5858
150	402	616	857	991	1 232	1 446	1 637	6407

Mounting instructions

Fastening torque M10 x 1,5 : 20 to 28 Nm

Indicative value of force to reach the minimum height at atmospheric pressure is 9 daN.



Bellow 12" x 2 Stainless steel

DB12227

INDUSTRY

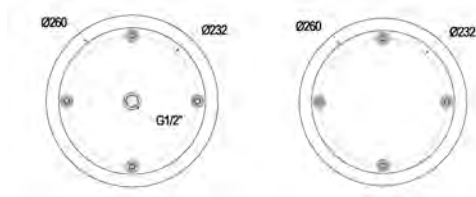
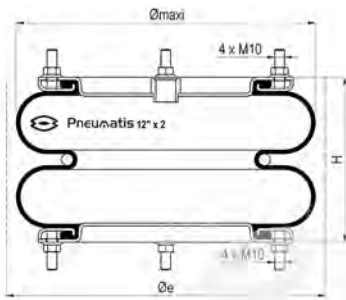

Technical characteristics

Maximum pressure	8 bar
Burst pressure	24 bar
Maximum angular capacity	15°
Maximum out of alignment	10 mm

Static diameter	305 mm
Maximum diameter	330 mm
Minimum overall diameter (Øe)	350 mm
Minimum height	75 mm
Static height (H)	170 mm
Maximum height	270 mm
Maximum recommended height	245 mm
Total stroke	195 mm
Effective area at static height	460 cm ²
Stiffness at 4 bar	39,00 daN/mm
Natural frequency at 4 bar	1,86 Hz
Weight	6,7 kg

Dynamic characteristics at H = 220mm*

Pressure	2 bar	4 bar	6 bar
Load (daN)	700	1465	2225
Volume (dm ³)	9,19	9,52	9,85
Stiffness (daN/mm)	109	200	285
Natural frequency (Hz)	1,97	1,84	1,78
Isolation rate at 10Hz %	96,0%	96,5%	96,7%

* Recommended height for better isolation

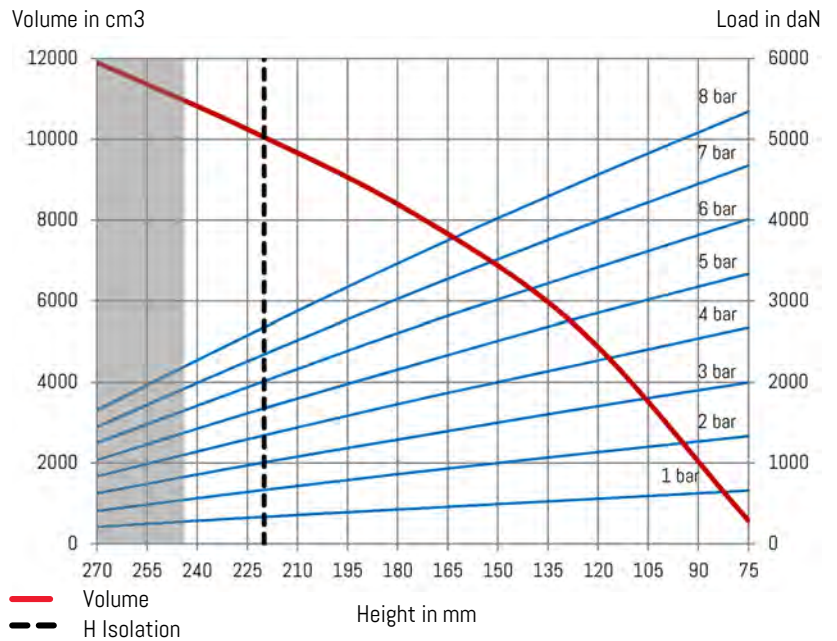

Temperatures

Standard	-40°C (-50°C static)	+70°C (+90°C static)
----------	----------------------	----------------------

References

DB12227	Bellow 2 convolutes 12" x 2 2 ply Stainless steel bolted air inlet G ^{1/2} centered
---------	--

Characteristics in static condition (daN)

Height	2 bar	3 bar	4 bar	5 bar	6 bar	7 bar	8 bar	Vol 5 bar
75	1 334	1 997	2 677	3 336	4 013	4 676	5 344	576
125	1 113	1 673	2 225	2 799	3 351	3 914	4 474	5266
170	909	1 364	1 819	2 279	2 740	3 192	3 650	7930
175	886	1 326	1 776	2 216	2 679	3 109	3 560	8154
220	667	1 005	1 339	1 674	2 013	2 344	2 679	10325
225	642	968	1 290	1 612	1 938	2 258	2 578	10512
245	541	819	1 091	1 359	1 635	1 902	2 172	11161
270	408	627	836	1 038	1 250	1 448	1 654	11902

Mounting instructions

Fastening torque M10 x 1,5 : 20 to 28 Nm

Indicative value of force to reach the minimum height at atmospheric pressure is 9 daN.

Bellow 12" x 3 reinforced Stainless steel

DB12332

INDUSTRY

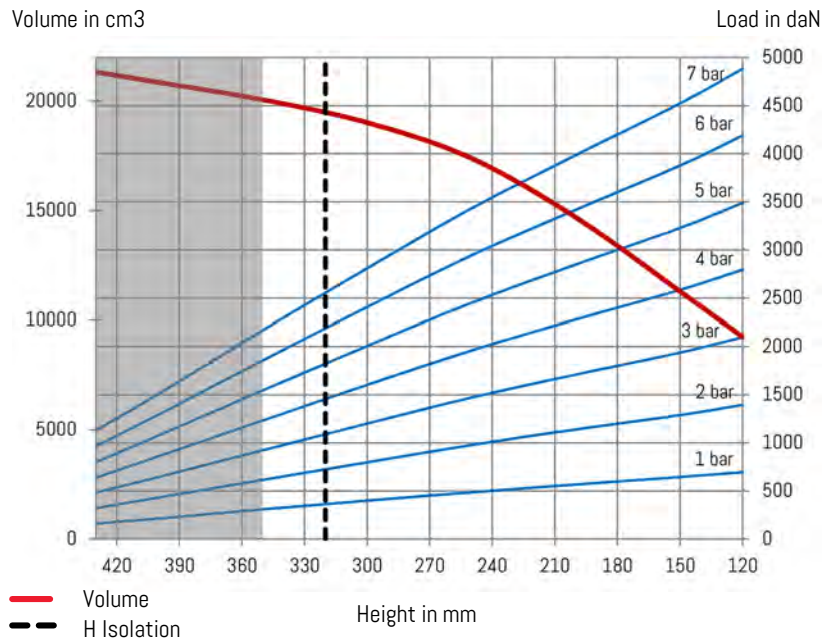
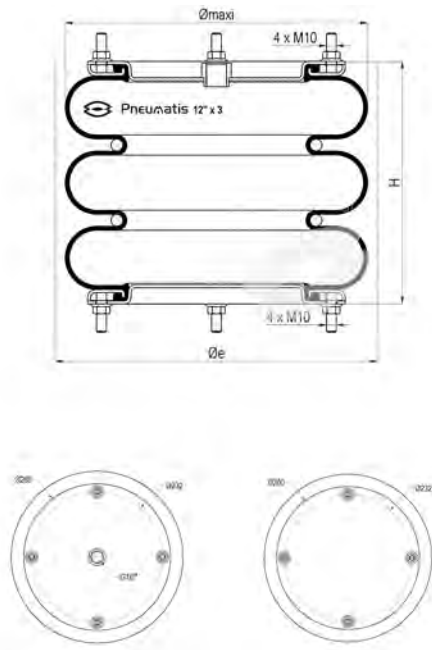

Technical characteristics

Maximum pressure	8 bar
Burst pressure	24 bar
Maximum angular capacity	
Maximum out of alignment	10 mm

Static diameter	305 mm
Maximum diameter	330 mm
Minimum overall diameter (Øe)	350 mm
Minimum height	120 mm
Static height (H)	250 mm
Maximum height	430 mm
Maximum recommended height	350 mm
Total stroke	310 mm
Effective area at static height	490 cm ²
Stiffness at 4 bar	30 daN/mm
Natural frequency at 4 bar	1,66 Hz
Weight	9 kg

Dynamic characteristics at H = 320mm*

Pressure	2 bar	4 bar	6 bar
Load (daN)	850	1595	2340
Volume (dm ³)	13,7	13,9	14,1
Stiffness (daN/mm)	98	156	215
Natural frequency (Hz)	1,69	1,56	1,51
Isolation rate at 10Hz %	97,1%	97,5%	97,7%

* Recommended height for better isolation

Temperatures

Standard	-40°C (-50°C static)	+70°C (+90°C static)
----------	----------------------	----------------------

References

DB12332	Bellow 3 convolutes 12" x 3 4 ply reinforced Stainless steel bolted air inlet G ^{1/2} centered
---------	---

Characteristics in static condition (daN)

Height	2 bar	3 bar	4 bar	5 bar	6 bar	7 bar	8 bar	Vol 5 bar
120	1 395	2 097	2 794	3 489	4 189	4 884		9243
150	1 289	1 938	2 585	3 228	3 877	4 523		11305
200	1 140	1 710	2 279	2 848	3 417	3 984	Contact us	14689
250	978	1 471	1 959	2 451	2 943	3 431		17394
300	798	1 201	1 603	2 006	2 408	2 809		19025
320	730	1 090	1 455	1 830	2 193	2 555		19637
350	616	924	1 233	1 546	1 857	2 169		20067
400	432	646	861	1 077	1 295	1 509		20866
430	321	484	639	799	961	1 130		21334

Mounting instructions

Fastening torque M10 x 1,5 : 20 to 28 Nm

Indicative value of force to reach the minimum height at atmospheric pressure is 90 daN.



Bellow 12" x 3 Stainless steel

DB12342

INDUSTRY

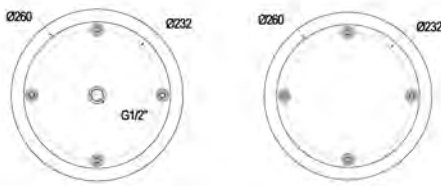
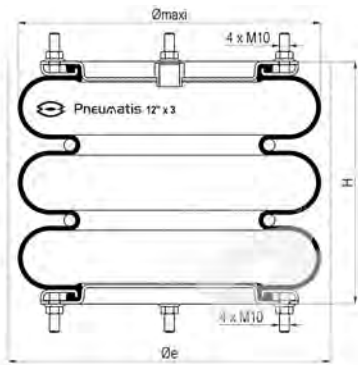

Technical characteristics

Maximum pressure	8 bar
Burst pressure	24 bar
Maximum angular capacity	15°
Maximum out of alignment	10 mm

Static diameter	305 mm
Maximum diameter	330 mm
Minimum overall diameter (\varnothing_e)	350 mm
Minimum height	100 mm
Static height (H)	250 mm
Maximum height	430 mm
Maximum recommended height	350 mm
Total stroke	330 mm
Effective area at static height	490 cm ²
Stiffness at 4 bar	30 daN/mm
Natural frequency at 4 bar	1,66 Hz
Weight	8,1 kg

Dynamic characteristics at H = 320mm*

Pressure	2 bar	4 bar	6 bar
Load (daN)	750	1510	2275
Volume (dm ³)	14,32	14,83	15,34
Stiffness (daN/mm)	76	133	189
Natural frequency (Hz)	1,58	1,48	1,44
Isolation rate at 10Hz %	97,4%	97,8%	97,9%

* Recommended height for better isolation

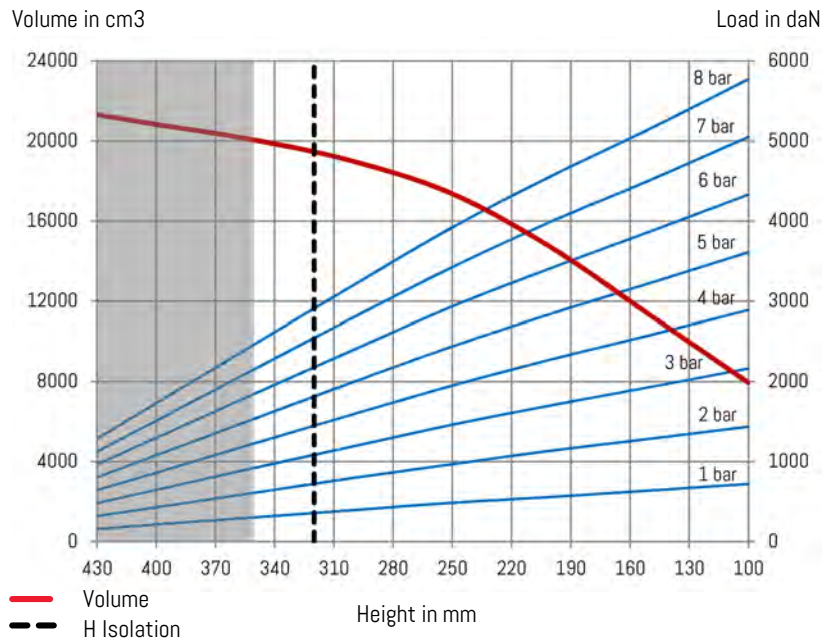

Temperatures

Standard	-40°C (-50°C static)	+70°C (+90°C static)
----------	----------------------	----------------------

References

DB12342	Bellow 3 convolutes 12" x 3 ply Stainless steel bolted air inlet G1/2 centered
---------	--

Characteristics in static condition (daN)

Height	2 bar	3 bar	4 bar	5 bar	6 bar	7 bar	8 bar	Vol 5 bar
100	1 438	2 165	2 891	3 610	4 332	5 052	5 773	7948
150	1 286	1 932	2 578	3 225	3 868	4 509	5 152	11318
200	1 138	1 704	2 277	2 844	3 413	3 993	4 561	14685
250	969	1 462	1 951	2 439	2 936	3 425	3 921	17360
300	797	1 193	1 595	1 998	2 397	2 800	3 202	18982
320	722	1 088	1 455	1 822	2 185	2 560	2 928	19565
350	613	924	1 231	1 539	1 851	2 159	2 469	20046
400	430	648	862	1 081	1 298	1 513	1 731	20832
430	321	483	645	805	967	1 126	1 286	21310

Mounting instructions

Fastening torque M10 x 1,5 : 20 to 28 Nm

Indicative value of force to reach the minimum height at atmospheric pressure is 10 daN.

Bellow 14" 1/2 x 1 Stainless steel

DB14111

INDUSTRY

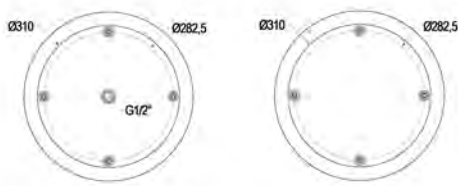
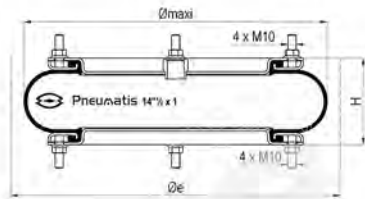

Technical characteristics

Maximum pressure	8 bar
Burst pressure	24 bar
Maximum angular capacity	10°
Maximum out of alignment	10 mm

Static diameter	368 mm
Maximum diameter	395 mm
Minimum overall diameter (Øe)	425 mm
Minimum height	50 mm
Static height (H)	110 mm
Maximum height	165 mm
Maximum recommended height	150 mm
Total stroke	115 mm
Effective area at static height	710 cm ²
Stiffness at 4 bar	112 daN/mm
Natural frequency at 4 bar	2,60 Hz
Weight	6,90 kg

Dynamic characteristics at H = 130mm*

Pressure	2 bar	4 bar	6 bar
Load (daN)	1325	2635	3940
Volume (dm ³)	8,66	8,97	9,28
Stiffness (daN/mm)	328	559	784
Natural frequency (Hz)	2,48	2,30	2,22
Isolation rate at 10Hz %	93,4%	94,4%	94,8%

* Recommended height for better isolation

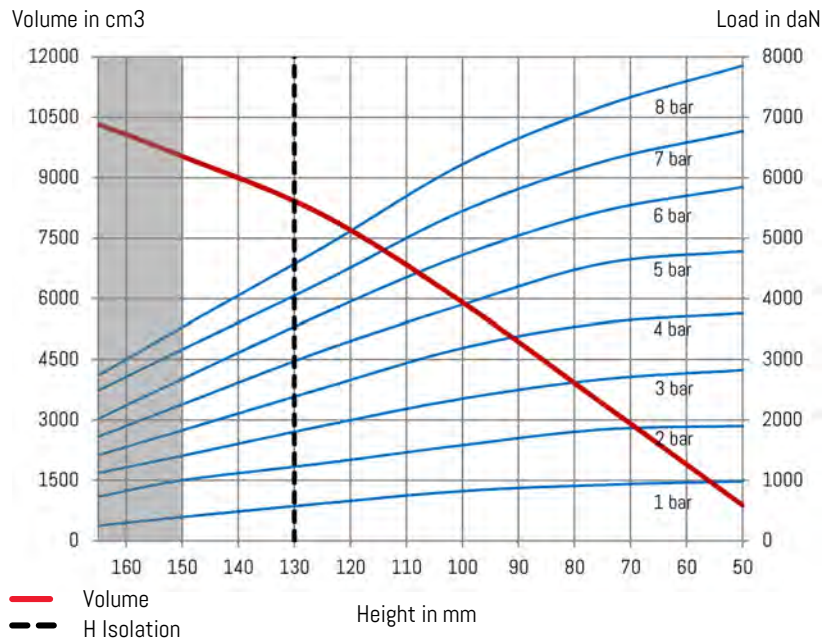

Temperatures

Standard	-40°C (-50°C static)	+70°C (+90°C static)
----------	----------------------	----------------------

References

DB14111	Bellow 1 convolute 14" 1/2 x 1 Stainless steel bolted air inlet G1/2 centered
---------	---

Characteristics in static condition (daN)

Height	2 bar	3 bar	4 bar	5 bar	6 bar	7 bar	8 bar	Vol 5 bar
50	1 901	2 826	3 759	4 785	5 847	6 771	7 856	883
75	1 843	2 673	3 602	4 581	5 447	6 266	7 181	3411
100	1 584	2 354	3 189	3 902	4 721	5 449	6 223	5911
110	1 493	2 186	2 942	3 648	4 361	5 002	5 688	6780
130	1 257	1 842	2 457	3 028	3 602	4 165	4 699	8298
125	1 282	1 902	2 523	3 143	3 748	4 277	4 841	8087
150	1 002	1 409	1 830	2 258	2 679	3 166	3 534	9535
165	730	1 122	1 420	1 724	2 018	2 492	2 736	10331

Mounting instructions

Fastening torque M10 x 1,5 : 20 to 28 Nm

Indicative value of force to reach the minimum height at atmospheric pressure is 8 daN.



Bellow 14" 1/2 x 2 Stainless steel

DB14222

INDUSTRY

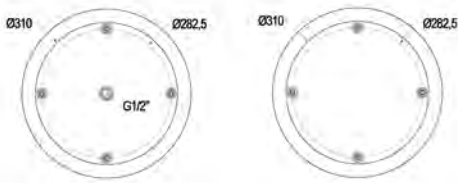
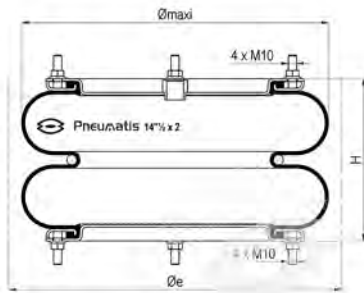

Technical characteristics

Maximum pressure	8 bar
Burst pressure	24 bar
Maximum angular capacity	15°
Maximum out of alignment	10 mm

Static diameter	368 mm
Maximum diameter	395 mm
Minimum overall diameter (Øe)	425 mm
Minimum height	70 mm
Static height (H)	180 mm
Maximum height	295 mm
Maximum recommended height	270 mm
Total stroke	225 mm
Effective area at static height	780 cm ²
Stiffness at 4 bar	53 daN/mm
Natural frequency at 4 bar	1,8 Hz
Weight	9,1 kg

Dynamic characteristics at H = 250mm*

Pressure	2 bar	4 bar	6 bar
Load (daN)	1185	2380	3560
Volume (dm ³)	17,2	17,8	18,4
Stiffness (daN/mm)	151	264	373
Natural frequency (Hz)	1,78	1,66	1,61
Isolation rate at 10Hz %	96,7%	97,2%	97,3%

* Recommended height for better isolation

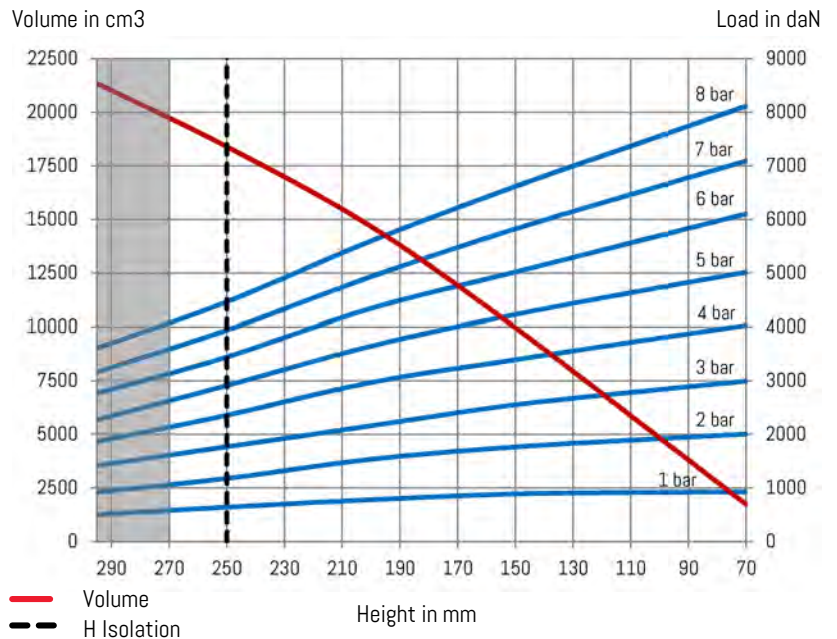

Temperatures

Standard	-40°C (-50°C static)	+70°C (+90°C static)
----------	----------------------	----------------------

References

DB14222	Bellow 2 convolutes 14" 1/2 x 2 Stainless steel bolted air inlet G1/2" centered
---------	---

Characteristics in static condition (daN)

Height	2 bar	3 bar	4 bar	5 bar	6 bar	7 bar	8 bar	Vol 5 bar
70	2 010	2996	4 031	5017	6 107	7093	8119	1744
100	1 923	2840	3 798	4734	5 701	6624	7558	4846
150	1 768	2556	3 395	4232	5 023	5826	6618	9970
200	1 539	2164	2 971	3647	4 346	4935	5601	14680
250	1 181	1772	2 361	2915	3 446	3945	4468	18403
295	925	1421	1 869	2273	2 770	3167	3609	21351

Mounting instructions

Fastening torque M10 x 1,5 : 20 to 28 Nm

Indicative value of force to reach the minimum height at atmospheric pressure is 8 daN.

Bellow 14" 1/2 x 3 Stainless steel

DB14333

INDUSTRY

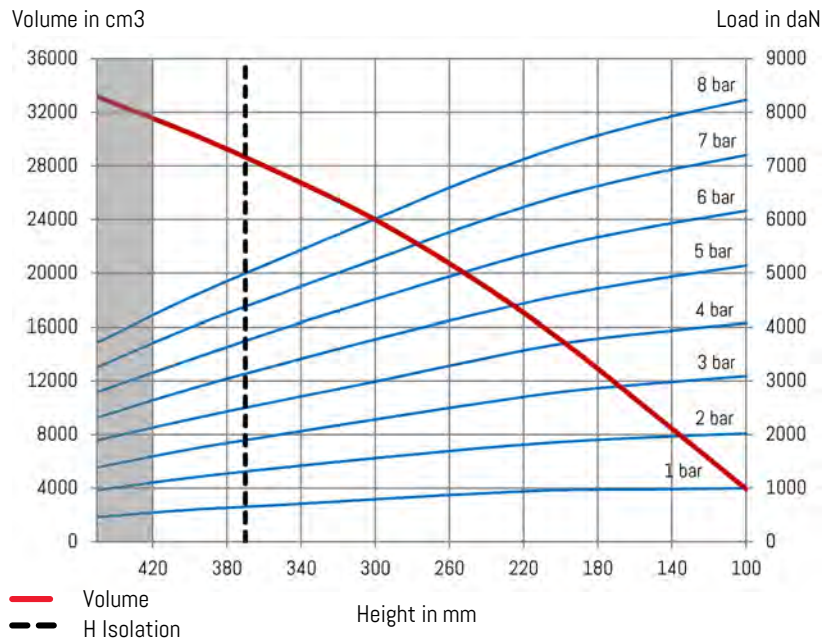
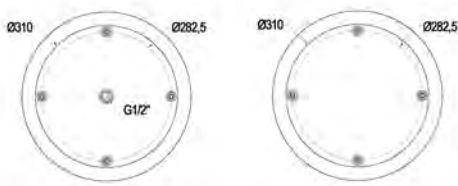
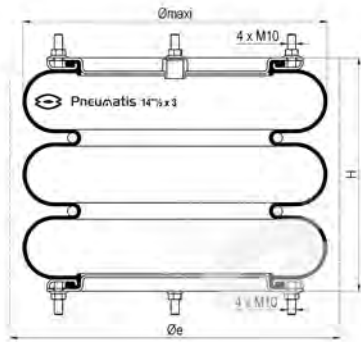

Technical characteristics

Maximum pressure	8 bar
Burst pressure	24 bar
Maximum angular capacity	15°
Maximum out of alignment	10 mm

Static diameter	368 mm
Maximum diameter	395 mm
Minimum overall diameter (Øe)	425 mm
Minimum height	100 mm
Static height (H)	280 mm
Maximum height	450 mm
Maximum recommended height	420 mm
Total stroke	350 mm
Effective area at static height	800 cm ²
Stiffness at 4 bar	32 daN/mm
Natural frequency at 4 bar	1,4 Hz
Weight	10 kg

Dynamic characteristics at H = 370mm*

Pressure	2 bar	4 bar	6 bar
Load (daN)	1110	2235	3365
Volume (dm ³)	26,07	26,97	27,86
Stiffness (daN/mm)	92	163	233
Natural frequency (Hz)	1,43	1,35	1,31
Isolation rate at 10Hz %	97,9%	98,1%	98,2%

* Recommended height for better isolation

Temperatures

Standard	-40°C (-50°C static)	+70°C (+90°C static)
----------	----------------------	----------------------

References

DB14333 Bellow 3 convolutes 14" 1/2 x 3 2 ply Stainless steel bolted air inlet G1/2 centered

Characteristics in static condition (daN)

Height	2 bar	3 bar	4 bar	5 bar	6 bar	7 bar	8 bar	Vol 5 bar
100	2 021	3 090	4 076	5 141	6 165	7 201	8 235	3945
150	1 952	2 955	3 903	4 884	5 873	6 863	7 845	9562
200	1 862	2 794	3 692	4 585	5 516	6 443	7 360	15064
250	1 725	2 550	3 355	4 200	5 042	5 887	6 734	19847
280	1 633	2 404	3 2158	3 957	4 745	5 536	6 330	22302
300	1 561	2 284	2 989	3 775	4 516	5 256	6 012	23992
350	1 384	2 007	2 642	3 320	3 975	4 631	5 288	27388
370	1 312	1 905	2 524	3 146	3 772	4 402	5 029	28806
400	1 194	1 725	2 284	2 847	3 394	3 990	4 545	30449
420	1 098	1 585	2 126	2 635	3 161	3 691	4 211	31642
450	963	1 386	1 896	2 317	2 793	3 258	3 708	33180

Mounting instructions

Fastening torque M10 x 1,5 : 20 to 28 Nm

Indicative value of force to reach the minimum height at atmospheric pressure is 29 daN.



Bellow 14" ½ x 3 reinforced Stainless steel

DB14334

INDUSTRY

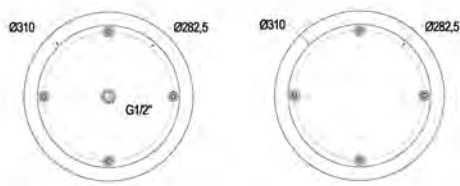
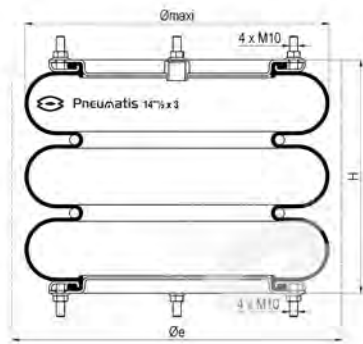

Technical characteristics

Maximum pressure	8 bar
Burst pressure	24 bar
Maximum angular capacity	15°
Maximum out of alignment	10 mm

Static diameter	368 mm
Maximum diameter	395 mm
Minimum overall diameter (Øe)	425 mm
Minimum height	120 mm
Static height (H)	280 mm
Maximum height	450 mm
Maximum recommended height	420 mm
Total stroke	330 mm
Effective area at static height	800 cm ²
Stiffness at 4 bar	32 daN/mm
Natural frequency at 4 bar	1,4 Hz
Weight	11 kg

Dynamic characteristics at H = 350mm*

Pressure	2 bar	4 bar	6 bar
Load (daN)	1095	2220	3350
Volume (dm ³)	23,8	24,0	24,2
Stiffness (daN/mm)	99	177	254
Natural frequency (Hz)	1,50	1,41	1,37
Isolation rate at 10Hz %	97,7%	98,0%	98,1%

* Recommended height for better isolation

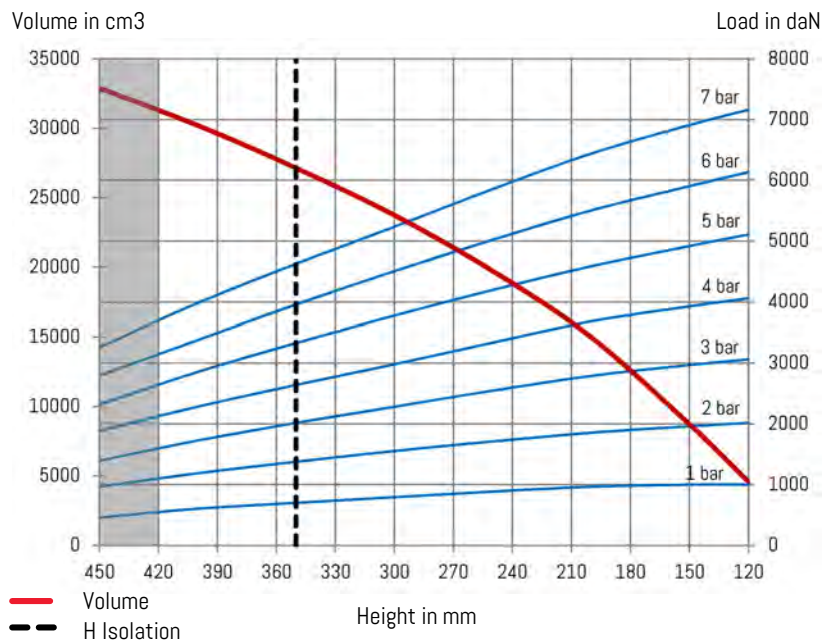

Temperatures

Standard	-40°C (-50°C static)	+70°C (+90°C static)
----------	----------------------	----------------------

References

DB14334	Bellow 3 convolutes 14" ½ x 3 4 ply reinforced Stainless steel bolted air inlet G1/2 centered
---------	---

Characteristics in static condition (daN)

Height	2 bar	3 bar	4 bar	5 bar	6 bar	7 bar	8 bar	Vol 5 bar
120	2 018	3 062	4 058	5 108	6 134	7 161		4595
150	1 961	2 969	3 926	4 918	5 904	6 909		8725
200	1 856	2 791	3 681	4 584	5 504	6 439		14986
250	1 711	2 548	3 337	4 195	5 021	5 857		19714
280	1 623	2 397	3 139	3 955	4 718	5 503		22230
300	1 554	2 283	2 982	3 775	4 504	5 235		23736
350	1 377	2 016	2 642	3 330	3 957	4 626		27135
370	1 307	1 898	2 503	3 146	3 748	4 368		28753
400	1 189	1 727	2 284	2 856	3 379	3 981		30202
420	1 102	1 584	2 116	2 646	3 157	3 680		31374
450	967	1 394	1 884	2 319	2 796	3 259		32898

Contact us

Mounting instructions

Fastening torque M10 x 1,5 : 20 to 28 Nm

Indicative value of force to reach the minimum height at atmospheric pressure is 85 daN.

Bellow 16" x 2 Stainless steel

DB16226

INDUSTRY

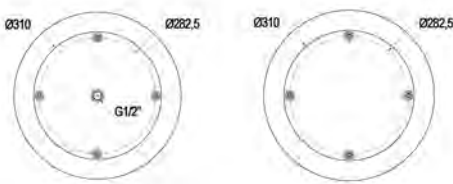
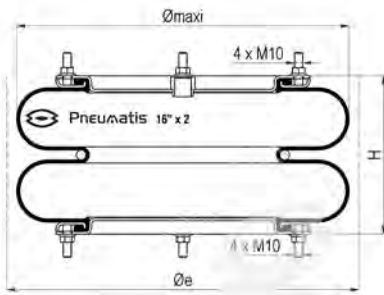

Technical characteristics

Maximum pressure	8 bar
Burst pressure	24 bar
Maximum angular capacity	15°
Maximum out of alignment	10 mm

Static diameter	406 mm
Maximum diameter	440 mm
Minimum overall diameter (Øe)	460 mm
Minimum height	75 mm
Static height (H)	200 mm
Maximum height	325 mm
Maximum recommended height	300 mm
Total stroke	250 mm
Effective area at static height	870 cm ²
Stiffness at 4 bar	63 daN/mm
Natural frequency at 4 bar	1,71 Hz
Weight	9,7 kg

Dynamic characteristics at H = 290mm*

Pressure	2 bar	4 bar	6 bar
Load (daN)	1270	2575	3865
Volume (dm ³)	24,25	24,85	25,46
Stiffness (daN/mm)	126	228	323
Natural frequency (Hz)	1,57	1,48	1,44
Isolation rate at 10Hz %	97,5%	97,8%	97,9%

* Recommended height for better isolation

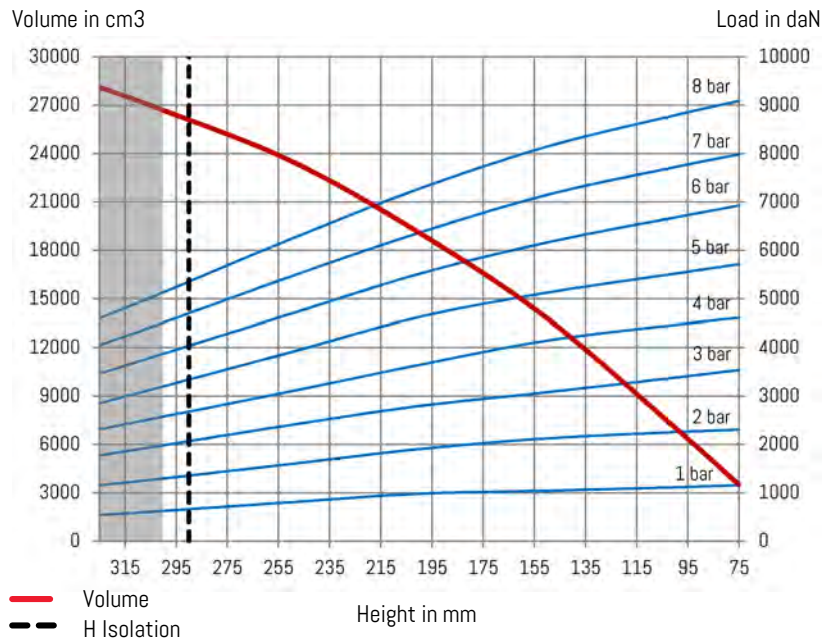

Temperatures

Standard	-40°C (-50°C static)	+70°C (+90°C static)
----------	----------------------	----------------------

References

DB16226	Bellow 2 convolutes 16" x 2 2 ply Stainless steel bolted air inlet G1/2 centered
---------	--

Characteristics in static condition (daN)

Height	2 bar	3 bar	4 bar	5 bar	6 bar	7 bar	8 bar	Vol 5 bar
75	2 306	3 539	4 614	5 714	6 925	7 984	9 090	3509
100	2 256	3 382	4 466	5 520	6 680	7 721	8 793	7039
150	2 125	3 080	4 146	5 127	6 164	7 147	8 145	13798
200	1 906	2 795	3 644	4 626	5 515	6 363	7 273	19094
250	1 598	2 405	3 100	3 908	4 695	5 464	6 237	23535
290	1 383	2 076	2 702	3 378	4 070	4 743	5 398	26229
300	1 298	1 984	2 575	3 201	3 874	4 512	5 133	26684
325	1 156	1 774	2 311	2 852	3 465	4 047	4 596	28120

Mounting instructions

Fastening torque M10 x 1,5 : 20 to 28 Nm

Indicative value of force to reach the minimum height at atmospheric pressure is 8 daN.



Bellow 16" x 3 reinforced Stainless steel

DB16321

INDUSTRY

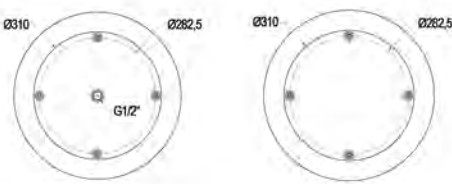
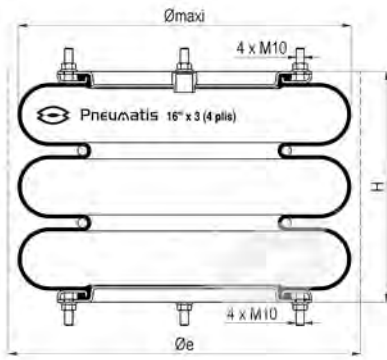

Technical characteristics

Maximum pressure	8 bar
Burst pressure	24 bar
Maximum angular capacity	15°
Maximum out of alignment	10 mm

Static diameter	406 mm
Maximum diameter	440 mm
Minimum overall diameter (Øe)	460 mm
Minimum height	85 mm
Static height (H)	200 mm
Maximum height	325 mm
Maximum recommended height	300 mm
Total stroke	240 mm
Effective area at static height	870 cm ²
Stiffness at 4 bar	63 daN/mm
Natural frequency at 4 bar	1,71 Hz
Weight	10,4 kg

Dynamic characteristics at H = 280mm*

Pressure	2 bar	4 bar	6 bar
Load (daN)	1255	2545	3825
Volume (dm ³)	22,2	22,6	22,9
Stiffness (daN/mm)	133	237	339
Natural frequency (Hz)	1,62	1,52	1,48
Isolation rate at 10Hz %	97,3%	97,6%	97,7%

* Recommended height for better isolation

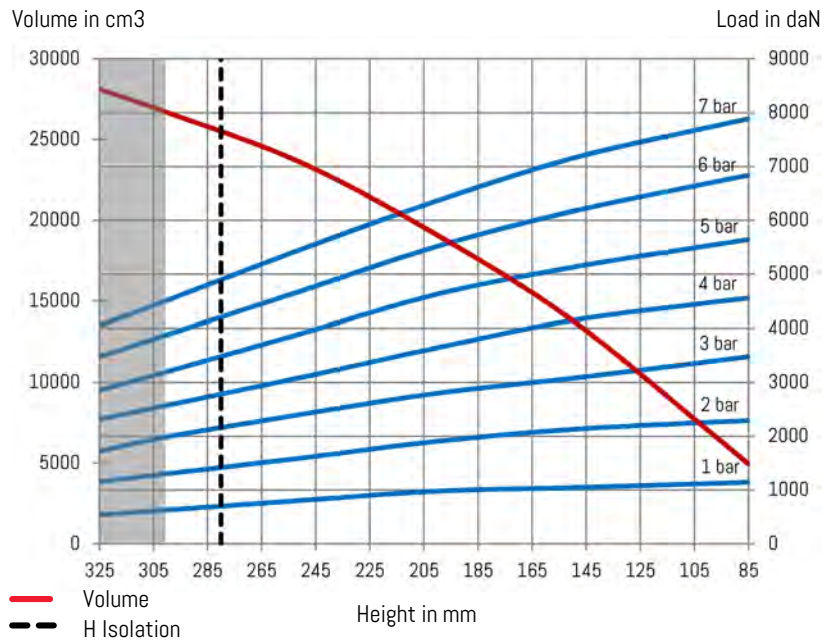

Temperatures

Standard	-40°C (-50°C static)	+70°C (+90°C static)
----------	----------------------	----------------------

References

DB16321	Bellow 2 convolutes 16" x 3 4 ply reinforced bolted Stainless steel screw air inlet G1/2 centered
---------	---

Characteristics in static condition (daN)

Height	2 bar	3 bar	4 bar	5 bar	6 bar	7 bar	8 bar	Vol 5 bar
85	2 290	3 480	4 557	5 642	6 837	7 885		4947
100	2 259	3 382	4 470	5 527	6 687	7 724		7039
150	2 128	3 078	4 147	5 129	6 168	7 154	Contact us	13812
200	1 906	2 798	3 643	4 631	5 518	6 365		19078
250	1 597	2 409	3 096	3 909	4 696	5 468		23546
280	1 448	2 153	2 817	3 529	4 246	4 943		25616
300	1 302	1 988	2 575	3 200	3 881	4 514		26684
325	1 156	1 722	2 315	2 853	3 473	4 047	28120	

Mounting instructions

Fastening torque M10 x 1,5 : 20 to 28 Nm

Indicative value of force to reach the minimum height at atmospheric pressure is 64 daN.